

TECHNICAL PARAMETERS Vibration exciter S 59389/AIT-440

Rated peak force Sine _{pk} /Random _{RMS} ¹ /Shock _{pk} ²	89000/89000/267000 N
Frequency range	5 - 2400 Hz
Main resonance frequency	2100 Hz
Max. displacement Sine/Random/Shock (Pk-Pk) ³	63.5/63.5/76.2 mm
Max. velocity Sine/Random/Shock	2.0/2.0/4.0 m/s
Max. acceleration Sine/Random/Shock	100/85/350 g
Suspension stiffness	175 N/mm
Effective moving mass	58 kg
Max. payload	910 kg
Total mass	4500 kg
Magnetic stray field ⁴	3.5 mT
Armature diameter	440 mm
Required compressed air supply	Min. 600 kPa
Interlocks	Temperature, displacement, water flow rate, differential pressure, overcurrent, compressed air, conductance

1) Random force according to ISO 5344:2004

2) Theoretical maximum shock value. Depends on payload, amplifier, shock and shock width

3) Impact by moving to static mass and frequency is possible

4) measured at 150 mm above armature inserts

For long-term tests, the load must be reduced to 80 %. Continuous operation at maximum load can cause damage.

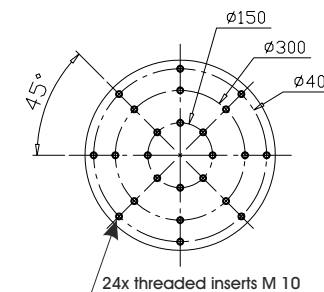
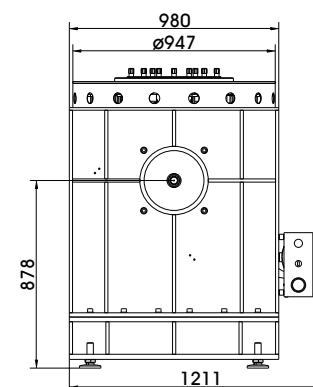
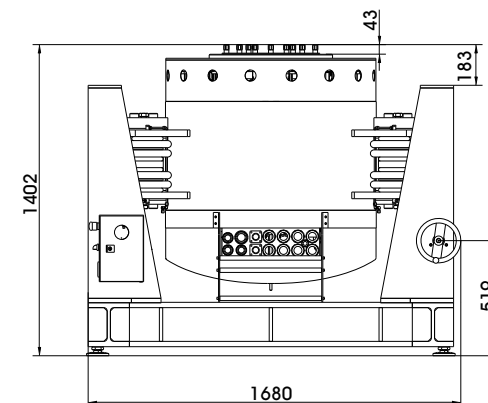

Armature 440 (Standard)

SCOPE OF DELIVERY, OPTIONS AND FEATURES OF THE SYSTEM

Scope of delivery:

Vibration exciter 89 kN
Trunnion mount
with integrated vibration isolation (AIT)
Power amplifier 135 kVA
Cooling unit with integrated hydraulic unit
Connection cables (each 10 m)
Water hoses with
self-sealing couplings (each 10 m)
Hydraulic hoses with
self-sealing couplings (each 10 m)
Compressed-air hose NW 7.2 (Standard)
(10 m)

Options:

Different hole pattern of armature (different
pitch diameter and/or thread inserts)
at customers request
Thermobarrier (-40°C to +140°C)
Chamber leadthrough
Climatic chamber support kit
Remote control (Software)
ASM-Mode (Auto Shutdown Manager)
Cable/Hose extension
Factory acceptance test

Features:

Vibration isolation < 3 Hz (AIT)
Fully automatic pneumatic load compensation
Low-friction hydrostatic bearing (Dual Bearing)
AIT fixable
Automatic centering of the AIT-System and
the armature
Degauss kit to reduce stray magnetic field
Shaker-water circuit with overpressure
Automatic permanent monitoring
of conductance
Integrated mains switch and line filter
Integrated field power supply
Energy-saving-mode
4 Sigma peak current
Made in Germany
Servicehotline

TECHNICAL PARAMETERS Power Amplifier A 5 40 11 252

Output power _{RMS}	135000 VA	Features: Field supply integrated Mains switch and integrated line filter Lo-Field/Hi-Field (Energy-saving mode) Field voltage/Field current variable according to customer spec. 4 Sigma peak current Color-Touchscreen
Frequency range	DC - 5 kHz	
Voltage _{RMS} max.	±212 V	
Current _{RMS} max.	1200 A	
Signal input voltage	10 V	
Total Harmonic Distortion (at 70A _{RMS} , 200 Hz)	< 0.2 %	
Signal to noise ratio	> 80 dB	
Field voltage	155 V	
Field current	260 A	
Total mass	2300 kg	
Dimensions (WxHxD)	2840 x 2200 x 1050 mm	
Power supply (Standard)	3~ / N / PE 400 V±5% 50 Hz	
Recommended fuse protection (Standard)	Direct connection (Terminal block) 250 A slow	
Max. power consumption at 400 V (incl. cooling unit)	143 kVA	
Interlocks:	Overload, Temperature, Displacement, Compressed air, Phase monitoring, Emergency stop, Differential pressure, Water flow rate, Conductance	



TECHNICAL PARAMETERS Cooling unit C 59410

Environmental conditions:		Features: Closed system --> No pollution and no water loss by evaporation The system works with a higher pressure --> No cavitation interferences at the measuring signal Manometers and flow meters at several places within the circuits Integrated conductance monitoring and demineralisation Fine filter with pollution monitoring Reduction of water consumption at part load by controlling of the process water flow Self-sealing couplings (free from leakage) Optional: Hose length according to customer specs (up to 20 m) Optional: Monitoring of data, warnings and error messages at the PC
Temperature	5 - 30 °C	
Relative humidity	10 - 80 %	
Energy transfer	max. 3 kW	
Process water:		
Temperature	5 - 15 °C	
Volume flow at max. supply temperature	10 m³/h	
Working pressure: supply - static	≤ 8 bar (≤ 800 kPa)	
Working pressure: dynamic differential pressure	≥ 3 bar (≥ 300 kPa)	
Dissipated heat flow	max. 110 kW	
Nominal width of supply pipes	R 1 1/4 IT (32 mm)	
pH value	7 ± 1	
Dimensions of dirt particles	< 25 µm	
Water hardness (total/carbonate)	< 1.4 mmol/l / < 0.9 mmol/l	
Total mass	550 kg	
Dimensions (WxHxD)	600 x 2140 x 970 mm	

